

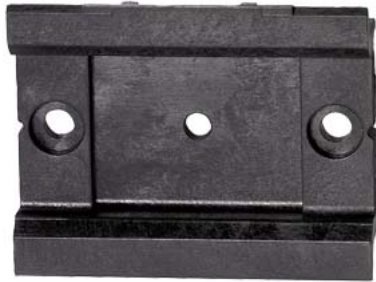









Несущая шина 45 мм, для монтажа, 3-фазные сборные шины 3RV2917-1/4



пригодность к использованию		силовой выключатель 3RV2	
Общие технические данные			
типоразмер автоматического выключателя		S00, S0	
Директива RoHS (дата)		07/01/2006	
Монтаж/ крепление/ размеры			
вид креплений		винтовое крепление	
Разрешения Сертификаты			
General Product Approval		Declaration of Conformity	Marine / Shipping
Confirmation      			
Marine / Shipping		other	
 		Confirmation 	

Дополнительная информация

Siemens has decided to exit the Russian market (see here).
<https://press.siemens.com/global/en/pressrelease/siemens-wind-down-russian-business>
 Siemens is working on the renewal of the current EAC certificates.
 Please contact your local Siemens office on the status of validity of the EAC certification if you intend to import or offer to supply these products to an EAC relevant market (other than the sanctioned EAEU member states Russia or Belarus).
Информация об упаковке
[Информация об упаковке](#)
 Information- and Downloadcenter (каталоги, брошюры,...)
<https://www.siemens.com/ic10>
 Industry Mall (Каталог и система обработки заказов)
<https://mall.industry.siemens.com/mall/ru/ru/Catalog/product?mlfb=3RV1917-7B>
 Онлайн-генератор Cax
<http://support.automation.siemens.com/WW/CAXorder/default.aspx?lang=en&mlfb=3RV1917-7B>
 Service&Support (руководства, инструкции по эксплуатации, сертификаты, указания, FAQ,...)
<https://support.industry.siemens.com/cs/ww/en/ps/3RV1917-7B>
 Банк изображений (фотографии продуктов, двухмерные размерные чертежи, трехмерные модели, схемы приборов, макросы EPLAN, ...)
http://www.automation.siemens.com/bilddb/cax_de.aspx?mlfb=3RV1917-7B&lang=en

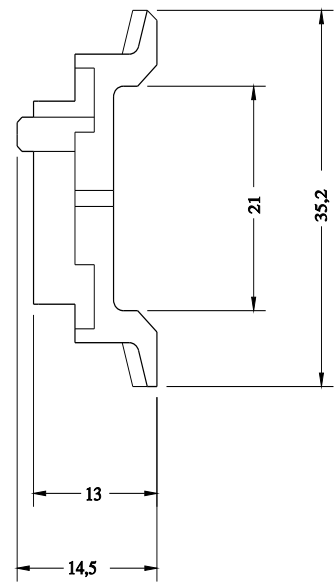
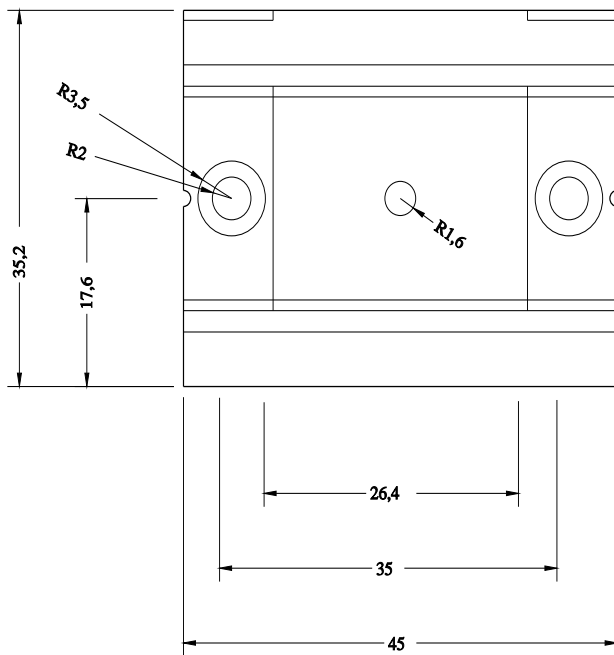

последнее изменение:

09.02.2022 